

DS-2DE7A412MCG-EB 4 MP 12 × Network Speed Dome

ColorVu AcuSense

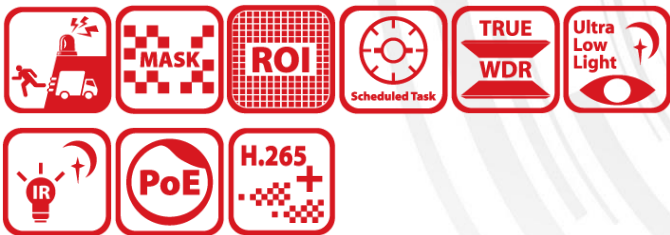

Hikvision DS-2DE7A412MCG-EB 4 MP 12 × Network Speed Dome adopts 1/1.8" progressive scan CMOS chip. With the 12 × optical zoom lens, the camera offers more details over expansive areas. This series of cameras can be widely used for wide ranges of high-definition, such as the rivers, roads, railways, airports, squares, parks, scenic spots, and venues, etc. Empowered by deep learning algorithms, Hikvision AcuSense technology brings human and vehicle targets classification alarms to front- and back-end devices. The system focuses on human and vehicle targets, vastly improving alarm efficiency and effectiveness.

- 24/7 colorful imaging
- High quality imaging with 4 MP resolution
- 12 × optical zoom and 16 × digital zoom provide close up views over expansive areas
- Audio visual alarm: The white flashing light and audible warning can be triggered by certain events
- Expansive night view with up to 150 m IR distance and 100 m white light
- Focuses on human and vehicle targets classification based on deep learning
- Face capture: Up to 5 faces captured at the same time

▪ DORI

The DORI (detect, observe, recognize, identify) distance gives the general idea of the camera ability to distinguish persons or objects within its field of view. It is calculated based on the camera sensor specification and the criteria given by EN 62676-4: 2015.

DORI	Detect	Observe	Recognize	Identify
Definition	25 px/m	63 px/m	125 px/m	250 px/m
Distance (Tele)	744.8 m (2443.6 ft)	295.6 m (969.8 ft)	149.0 m (488.9 ft)	74.5 m (244.4 ft)

▪ Specification

Camera	
Image Sensor	1/1.8" Progressive Scan CMOS
Max. Resolution	2560 × 1440
Min. Illumination	Color:0.0005Lux @ (F1.2, AGC ON), B/W:0.0001Lux @ (F1.2, AGC ON), 0 lux with light
Shutter Speed	1/1 s to 1/30000 s
Slow Shutter	Yes
Day & Night	IR cut filter
Zoom	12 × optical, 16 × digital
Lens	
Focal Length	6.7 mm to 80.4 mm
Zoom Speed	Approx. 5.8 s
FOV	Horizontal field of view: 51.5° to 7.9° (wide-tele), Vertical field of view: 30.3° to 4.4° (wide-tele), Diagonal field of view: 57.9° to 9.0° (wide-tele)
Aperture	Max. F1.2
Focus	Auto, semi-auto, manual
Illuminator	
Supplement Light Range	White light: up to 100 m IR: up to 150 m
Supplement Light Type	Hybrid(IR and White Light)
PTZ	
Movement Range (Pan)	360°
Movement Range (Tilt)	-15° to 90° (auto flip)
Pan Speed	Pan speed: configurable from 0.1° to 160°/s; preset speed: 240°/s
Tilt Speed	Tilt speed: configurable from 0.1° to 120°/s, preset speed 200°/s
Proportional Pan	Yes
Presets	300
Patrol Scan	8 patrols, up to 32 presets for each patrol
Pattern Scan	4 pattern scans
Power-off Memory	Yes
Park Action	Preset, patrol scan, pattern scan, auto scan, tilt scan, random scan, frame scan, panorama scan
3D Positioning	Yes
PTZ Status Display	Yes
Preset Freezing	Yes

Scheduled Task	Preset, pattern scan, patrol scan, auto scan, tilt scan, random scan, frame scan, panorama scan, dome reboot, dome adjust, aux output
Video	
Main Stream	50 Hz: 25 fps(2560 × 1440, 1920 × 1080, 1280 × 960, 1280 × 720) 60 Hz: 30 fps(2560 × 1440, 1920 × 1080, 1280 × 960, 1280 × 720)
Sub-Stream	50 Hz: 25 fps (704 × 576, 640 × 480, 352 × 288) 60 Hz: 30 fps (704 × 480, 640 × 480, 352 × 240)
Third Stream	50 Hz: 25 fps (1920 × 1080, 1280 × 960, 1280 × 720, 704 × 576, 640 × 480, 352 × 288); 60 Hz: 30 fps (1920 × 1080, 1280 × 960, 1280 × 720, 704 × 480, 640 × 480, 352 × 240)
Video Compression	Main stream: H.265+/H.265/H.264+/H.264 Sub-stream: H.265/H.264/MJPEG Third stream: H.265/H.264/MJPEG
Video Bit Rate	32 kbps to 16384 kbps
H.264 Type	Baseline Profile/Main Profile/High Profile
H.265 Type	Main Profile
Scalable Video Coding (SVC)	H.264 and H.265 encoding
Region of Interest (ROI)	8 fixed regions for each stream
Audio	
Audio Compression	G.711alaw, G.711ulaw, G.722.1, G.726, MP2L2, PCM, AAC-LC
Audio Bit Rate	64 Kbps (G.711)/16 Kbps (G.722.1)/16 Kbps (G.726)/32 to 192 Kbps (MP2L2)/16 to 64 Kbps (AAC-LC)
Audio Sampling Rate	8 kHz/16 kHz/32 kHz/48 kHz
Environment Noise Filtering	Yes
Network	
Network Storage	NAS (NFS, SMB/CIFS), auto network replenishment (ANR)
Protocols	IPv4/IPv6, HTTP, HTTPS, 802.1x, QoS, FTP, SMTP, UPnP, SNMP, DNS, DDNS, NTP, RTSP, RTCP, RTP, TCP/IP, UDP, IGMP, ICMP, DHCP, PPPoE, Bonjour, WebSocket, WebSockets
API	Open Network Video Interface (Version 19.12, Profile S, Profile G, Profile T), ISAPI, SDK, ISUP
Simultaneous Live View	Up to 20 channels
User/Host	Up to 32 users, 3 user levels: administrator, operator, and user
Security	Password protection, complicated password, HTTPS encryption, 802.1X authentication (EAP-TLS, EAP-LEAP, EAP-MD5), watermark, IP address filter, basic and digest authentication for HTTP/HTTPS, RTP/RTSP over HTTPS, control timeout settings, security audit log, TLS 1.2, TLS 1.3, host authentication (MAC address)
Client	iVMS-4200, HikCentral Pro, Hik-Connect
Web Browser	IE11, Chrome 57+, Firefox 52+, Safari 11+
Image	
Day/Night Switch	Day, Night, Auto, Schedule
Image Enhancement	BLC, HLC, 3D DNR
Wide Dynamic Range (WDR)	120 dB
Defog	Digital defog
Image Stabilization	EIS
Regional Exposure	Yes
Regional Focus	Yes

Image Settings	Saturation, brightness, contrast, sharpness, gain, and white balance adjustable by client software or web browser
Privacy Mask	24 programmable polygon privacy masks, mask color or mosaic configurable
SNR	> 52 dB
Interface	
Ethernet Interface	1 RJ45 10M/100M self-adaptive Ethernet port
On-board Storage	Built-in memory card slot, support microSD/SDHC/SDXC card, up to 256 GB
Alarm	2 inputs, 1 output
Reset	Yes
Audio	1 input (line in), max. input amplitude: 2-2.4 vpp, input impedance: 1 kΩ ± 10%; 1 output (line out), line level, output impedance: 600 Ω
Built-in Speaker	1 built-in speaker with effective distance reaching max. 30 meters
Event	
Basic Event	Motion detection, video tampering alarm, exception, alarm input and output
Smart Event	Line crossing detection, intrusion detection, region entrance detection, region exiting detection, unattended baggage detection, object removal detection, audio exception detection
Smart Tracking	Manual tracking, auto-tracking
Alarm Linkage	Upload to FTP/NAS/memory card, notify surveillance center, send email, trigger alarm output, trigger recording, audible warning, white light flashing, and PTZ actions (such as preset, patrol scan, pattern scan)
Deep Learning Function	
Face Capture	Detects up to 5 faces simultaneously. Supports detecting, capturing, grading, selecting of face in motion, and output the best face picture of the face
Perimeter Protection	Line crossing, intrusion, region entrance, region exiting Support alarm triggering by specified target types (human and vehicle)
General	
Power	24 VAC, max. 42 W (including max. 12 W for IR and max. 2 W for heater); Hi-PoE
Operating Condition	-30 °C to 65 °C (-22 °F to 149 °F). Humidity 90% or less (non-condensing)
Demist	Yes
Material	ADC12
Dimension	∅ 220 mm × 357.3 mm (∅8.66" × 14.07")
Weight	Approx. 5.5 kg (12.13 lb.)
Approval	
Protection	IP66 (IEC 60529-2013), IK10 (excluding glass window), TVS 6000V lightning protection, surge protection and voltage transient protection
EMC	FCC SDoC (47 CFR Part 15, Subpart B); CE-EMC (EN 55032: 2015, EN 61000-3-2: 2019, EN 61000-3-3: 2013, EN 50130-4: 2011 +A1: 2014); RCM (AS/NZS CISPR 32: 2015); IC VoC (ICES-003: Issue 6, 2019); KC (KN 32: 2015, KN 35: 2015)

Safety	UL (UL 62368-1); CB (IEC 60950-1:2005 + Am 1:2009 + Am 2:2013, IEC 62368-1:2014); CE-LVD (EN 62368-1:2014+A11:2017); BIS (IS 13252(Part 1):2010+A1:2013+A2:2015); LOA (SANS IEC60950-1)
Environment	CE-RoHS (2011/65/EU); WEEE (2012/19/EU); Reach (Regulation (EC) No 1907/2006)

▪ **Available Model**

DS-2DE7A412MCG-EB

▪ **Dimension**

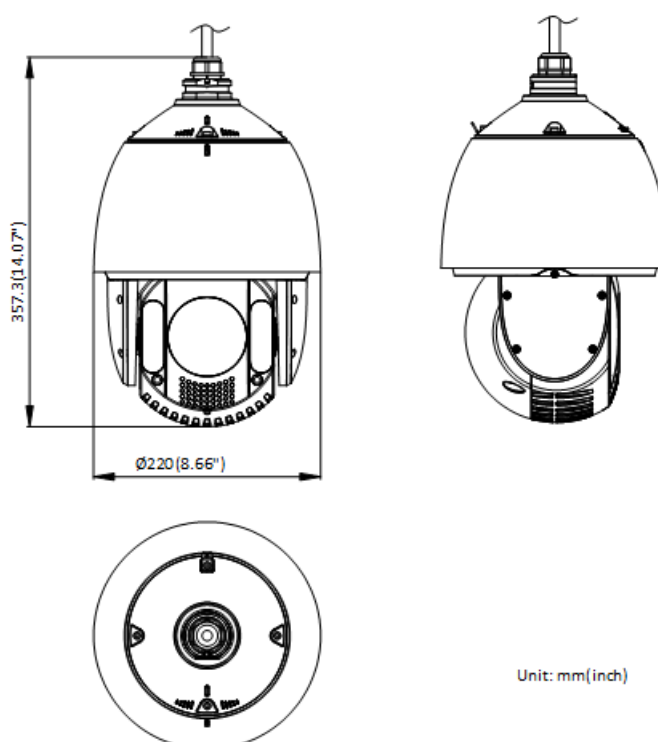















▪ **Accessory**

▪ **Included**



▪ **Optional**

<p>CPM-S Ceiling Mount</p>	<p>JBPW-L Wall Mount</p>	<p>SNB-PV Pendant Mount</p>	<p>DS-1681ZJ</p>	<p>JBPW Wall Mount</p>
				
<p>PMPL Pole Mount</p>	<p>DS-1100KI(B) Network Keyboard</p>	<p>CPMPE</p>	<p>CMPL Wall Mount with Junction Box</p>	<p>DS-1681ZJ-2</p>
				
<p>CPM-L Pendant Mount</p>	<p>CPM-S Pendant Mount</p>	<p>RPM Parapet Wall Mount</p>	<p>DS-1667ZJ Pendant Mount</p>	<p>PMP Vertical Pole Mount</p>
				

Headquarters

No.555 Qianmo Road, Binjiang District,
Hangzhou 310051, China
T +86-571-8807-5998
www.hikvision.com



Follow us on social media to get the latest product and solution information.

