

**HIKVISION®**

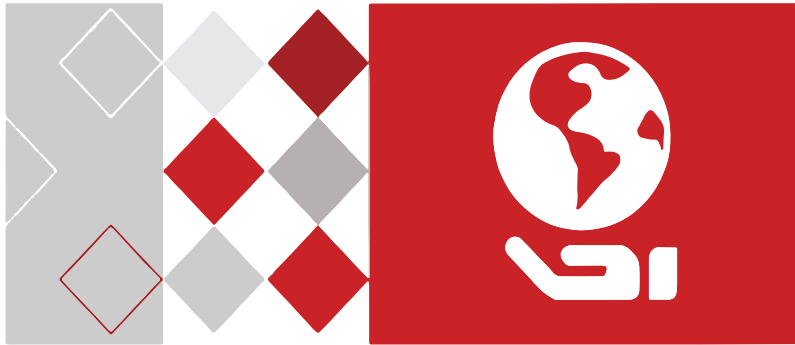

**ECT-D32V2**  
**TurboHD Dome Camera**  
Quick Start Guide

## Manual Illustrations and Features

Graphics (screen shots, product pictures, etc.) in this document are for illustrative purposes only. Your actual product may differ in appearance. Your product might not support all features discussed in this document.

**Hikvision USA Inc.**, 18639 Railroad St., City of Industry, CA 91748, USA • Hikvision Canada, 4848 rue Levy, Saint Laurent, Quebec, Canada, H4R 2P1

Telephone: +1-909-895-0400 • Toll Free in USA: +1-866-200-6690 • E-Mail: sales.usa@hikvision.com • www.hikvision.com

COPYRIGHT © 2018 Hangzhou Hikvision Digital Technology Co., Ltd.

**ALL RIGHTS RESERVED.**

## IMPORTANT INFORMATION FOR SECURITY

You must carefully read this manual before use and installation of the camera and keep this manual properly.

This manual may contain several technical incorrect places or printing errors, and the content is subject to change without notice. The updates will be added to the new version of this manual. We will readily improve or update the products or procedures described in the manual.

## Regulatory Information

### FCC Information

**FCC Compliance:** This equipment has been tested and found to comply with the limits for a digital device, pursuant to part 15 of the FCC Rules. These limits are designed to provide reasonable protection against harmful interference when the equipment is operated in a commercial environment. This equipment generates, uses, and can radiate radio frequency energy and, if not installed and used in accordance with the instruction manual, may cause harmful interference to radio communications. Operation of this equipment in a residential area is likely to cause harmful interference in which case the user will be required to correct the interference at his own expense.

### FCC Conditions

This device complies with part 15 of the FCC Rules. Operation is subject to the following two conditions:

This device may not cause harmful interference.

This device must accept any interference received, including interference that may cause undesired operation.

## EU Conformity Statement



This product and, if applicable, the supplied accessories too are marked with “CE” and comply therefore with the applicable harmonized European standards listed under the Low Voltage Directive 2006/95/EC, the EMC Directive 2004/108/EC, the RoHS Directive 2011/65/EU.



**2012/19/EU (WEEE Directive):** Products marked with this symbol cannot be disposed of as unsorted municipal waste in the European Union. For proper recycling, return this product to your local supplier upon the purchase of equivalent new equipment, or dispose of it at designated collection points. For more information see: [www.recyclethis.info](http://www.recyclethis.info).



**2006/66/EC (Battery Directive):** This product contains a battery that cannot be disposed of as unsorted municipal waste in the European Union. See the product documentation for specific battery information. The battery is marked with this symbol, which may include lettering to indicate cadmium (Cd), lead (Pb), or mercury (Hg). For proper recycling, return the battery to your supplier or to a designated collection point. For more information see: [www.recyclethis.info](http://www.recyclethis.info).

### Industry Canada ICES-003 Compliance

This device meets the CAN ICES-3 (A)/NMB-3(A) standards requirements.

## 1 Introduction

### 1.1 Product Features

This camera's high sensitivity and advanced circuit board design features high resolution, low distortion, low noise, etc. It is suitable for supervisory and image processing systems.

The main features are as follows:

- High performance CMOS sensor and high resolution
- Low illumination
- IR cut filter with auto switch
- OSD menu, parameters are configurable
- Auto white balance, auto gain control, electronic shutter control, and internal synchronization
- SMART IR mode
- Unit transmission control
- Advanced 3-axis design for flexible installation

## 1.2 Overview

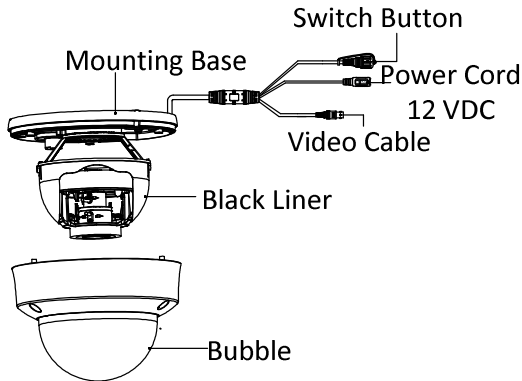

Figure 1 Dome Camera Overview

## 2 Installation

Both wall mounting and ceiling mounting are suitable for the dome camera. Ceiling mounting will be taken as an example in this section. Use the ceiling mounting steps as a reference for wall mounting.

### *Before You Start*

- Make sure that the device in the package is in good condition and all the assembly parts are included.
- Make sure that all the related equipment is powered-off during the installation.
- Check the specification of the products for the installation environment.
- Check whether the power supply matches your power output to avoid damage.
- Make sure the wall is strong enough to withstand three times the weight of the camera and the mounting.
- If the wall is a cement wall, insert expansion screws before you install the camera.
- If the wall is wood, use self-tapping screws to secure the camera.

- If the product does not function properly, contact your dealer or the nearest service center. Do not disassemble the camera for repair or maintenance yourself.

**Steps:**

1. Paste the drill template to the ceiling.
2. Drill screw holes and the cable hole (optional) on the ceiling according to the supplied drill template.

**Note:**

Drill the cable hole when using the ceiling outlet to route the cable.

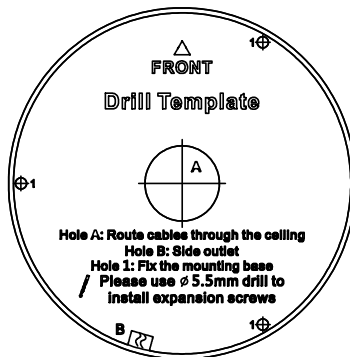

The Drill Template

3. Loosen the screws on the bubble of the dome camera to remove the bubble and the black liner.
4. Attach the mounting base to the ceiling, and secure them with supplied screws.

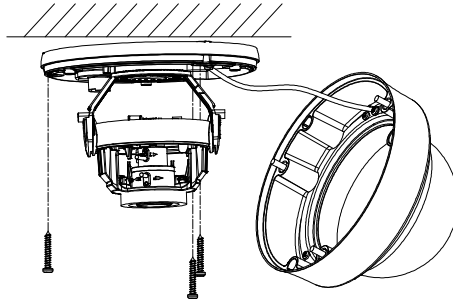

### Secure the Mounting Base

**Note:**

- The supplied screw package contains both self-tapping screws and expansion bolts.
  - For a cement ceiling, expansion bolts are required to fix the camera. For a wooden ceiling, self-tapping screws are required.
5. Route the cables through the cable hole or the side opening.
  6. Connect the corresponding cables such as power cable and video cable.
  7. Power on the camera to check if the image on the monitor is at an optimum angle. If not, adjust the camera according to the figure below to get an optimum angle.

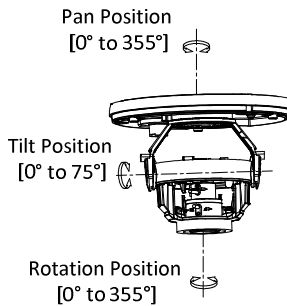

### 3-Axis Adjustment

8. Fit the black liner back to the camera, and tighten the screws on the bubble of the dome camera to finish the installation.

## 3 Menu Operation

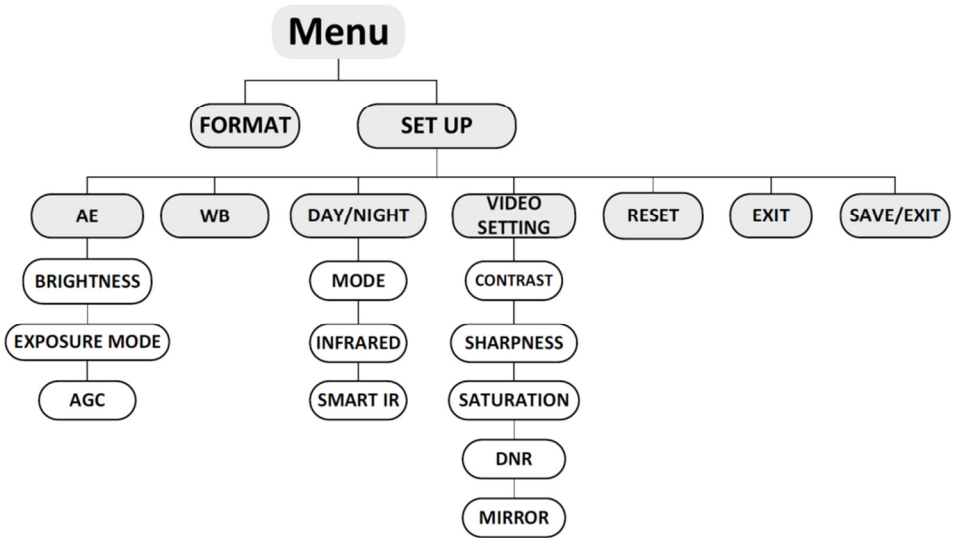

Figure 2 Main Menu

**NOTE:** With a coaxial camera controller (purchase separately) or calling preset No. 95 you can select the menu and adjust the camera parameters.

### 3.1 FORMAT

You can set the format to PAL/NTSC.

### 3.2 SET UP

Move the cursor to **SET UP**, and press the **MENU** button to enter the **SET UP** sub menu.

#### 3.2.1 AE

Move the cursor to AE, and you can adjust the image brightness by the **BRIGHTNESS**, **EXPOSURE MODE**, and **AGC**.

- **Brightness**  
Brightness refers to the brightness of the image.

- **Exposure Mode**

Move the cursor to **Exposure Mode**, you can select the exposure mode between **Globe** and **BLC**.

When BLC is selected as the exposure mode, the BLC mode level can be adjusted.

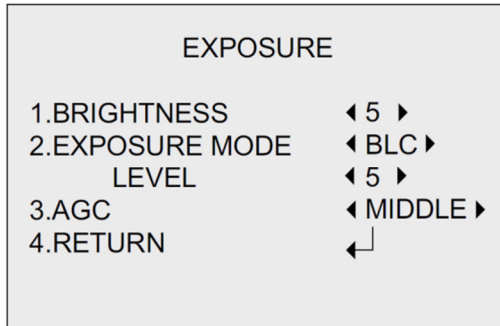

Figure 3 Exposure

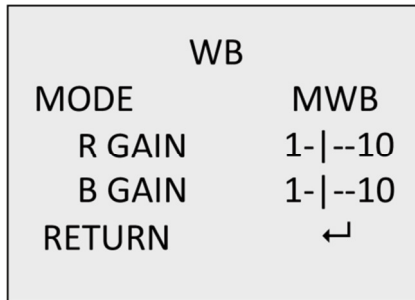

Figure 4 WB

- **AGC**

AGC optimizes the clarity of image in poor light scenes. AGC level can be set to OFF, LOW, MIDDLE, and HIGH.

### 3.2.2 WB

Move the cursor to **WB**, and you can set White Balance mode as **AWB** and **MWB** in this menu.



- **AWB**  
White balance is adjusted automatically.
- **MWB**  
Set the R GAIN/B GAIN value from 1 to 10.

### 3.2.3 DAY/NIGHT

Move the cursor to **DAY/NIGHT**, and select **COLOR**, **B/W**, or **SMART** as the **DAY/NIGHT** mode.

- **COLOR:** The image is colored in day mode all the time.
- **B/W:** The image is black and white all the time, and the IR LED turns on in low-light conditions.
- **SMART:** Select to turn on/off the INFRARED\_LAMP and to set the Smart IR level from 1 to 16.

DAY/NIGHT	
MODE	SMART
INFRARED	OFF
SMART IR	0- --5
RETURN	←

Figure 5 Day/Night

### 3.2.4 VIDEO SETTING

- **Contrast**  
Contrast enhances the difference in color and light between parts of an image. You can set the value from 1 to 10.
- **Sharpness**  
Sharpness determines the amount of detail that an imaging system can reproduce. You can set the value from 1 to 10.

- **Saturation**  
Set the saturation level of the image. The value is from 0 to 10.
- **DNR**  
DNR decreases the noise effect, especially in low light conditions, and delivers more accurate and sharp image quality. You can set the value from 0 to 7.
- **Mirror**  
You can set the Mirror status as H, V, HV, or OFF.
- **Reset**  
Reset all the settings to the defaults.
- **EXIT**  
**Exit** and **Save & Exit** are selectable.
- **SAVE/EXIT**  
Move the cursor to **SAVE & Exit**, and press **OK** to save the settings and exit the menu.